

1 2 3 4 5 6

A

B

C

D

Supervisory Interlock Master Sheet  
Cable Loop SchDoc:Fan Control SchDoc:Interlock SchDoc:Power SchDoc



Use UBC Logo  
SCUBA2 Interlock/Fan Controller

 <b>University of British Columbia</b> Physics & Astronomy Department 6224 Agricultural Road Vancouver BC V6T 1Z1 Canada			
<b>Controller Board Master</b>			
Size: B	Number: SC2-ELE-S588-104	Revision: A	
Date: 2007-03-05	Time: 09:20:25	Sheet 1	of 5
File: Master.SchDoc			

1 2 3 4 5 6

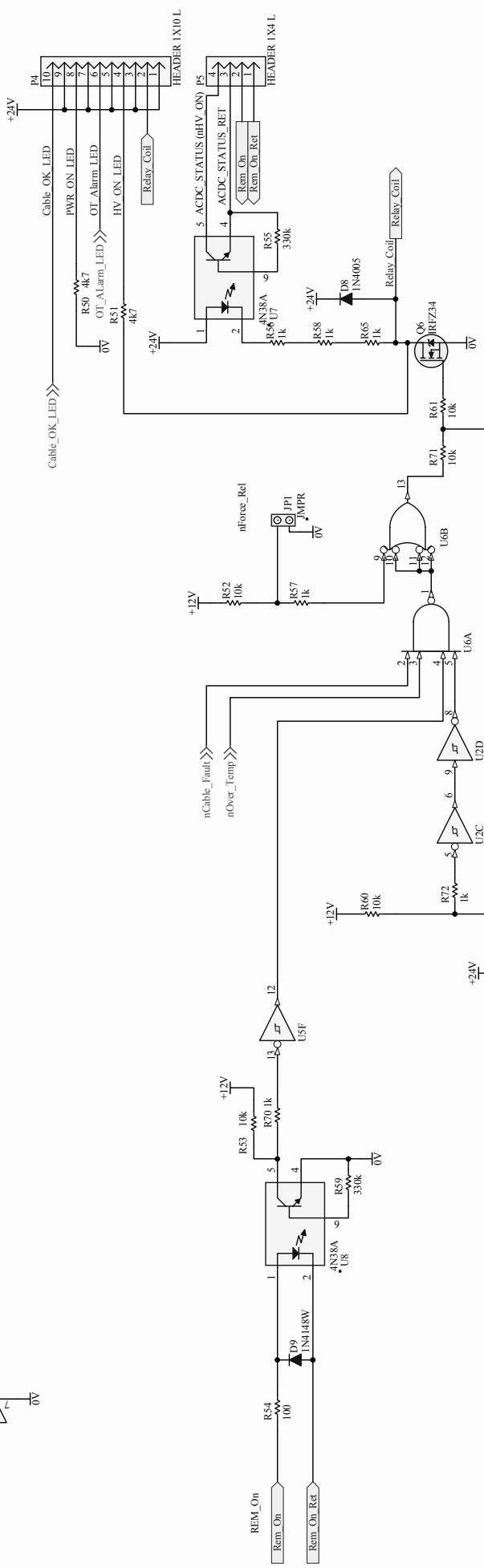
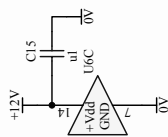

 <b>University of British Columbia</b> Physics & Astronomy Department 6224 Agricultural Road Vancouver BC V6T 1Z1 Canada	
<b>Title</b> Interlock	<b>Revision</b> A
<b>Size</b> B	<b>Number</b> SC2-ELE-S588-105
<b>Date</b> 2007-03-05	<b>Time</b> 09:20:25
<b>File</b> Interlock.SchDoc	<b>Sheet</b> 2 of 5

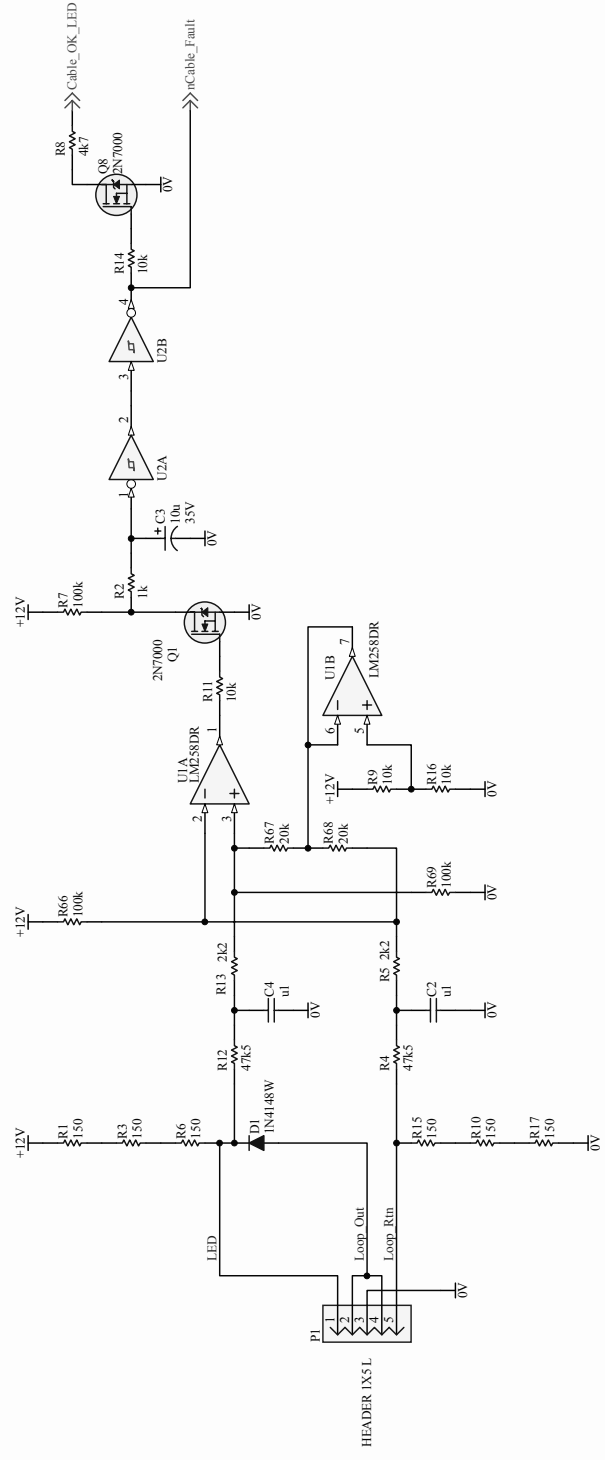
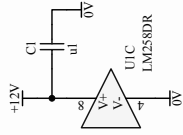

	
<b>University of British Columbia</b> Physics & Astronomy Department 6224 Agricultural Road Vancouver BC V6T 1Z1 Canada	
Title <b>Cable Loop</b>	Revision A
Size B	Number SC2-ELE-S588-104
Date 2007-03-05	Time 09:20:25
File Cable_Loop_SchDoc	Sheet 3 of 5

1 2 3 4 5 6

A B C D

1 2 3 4 5 6

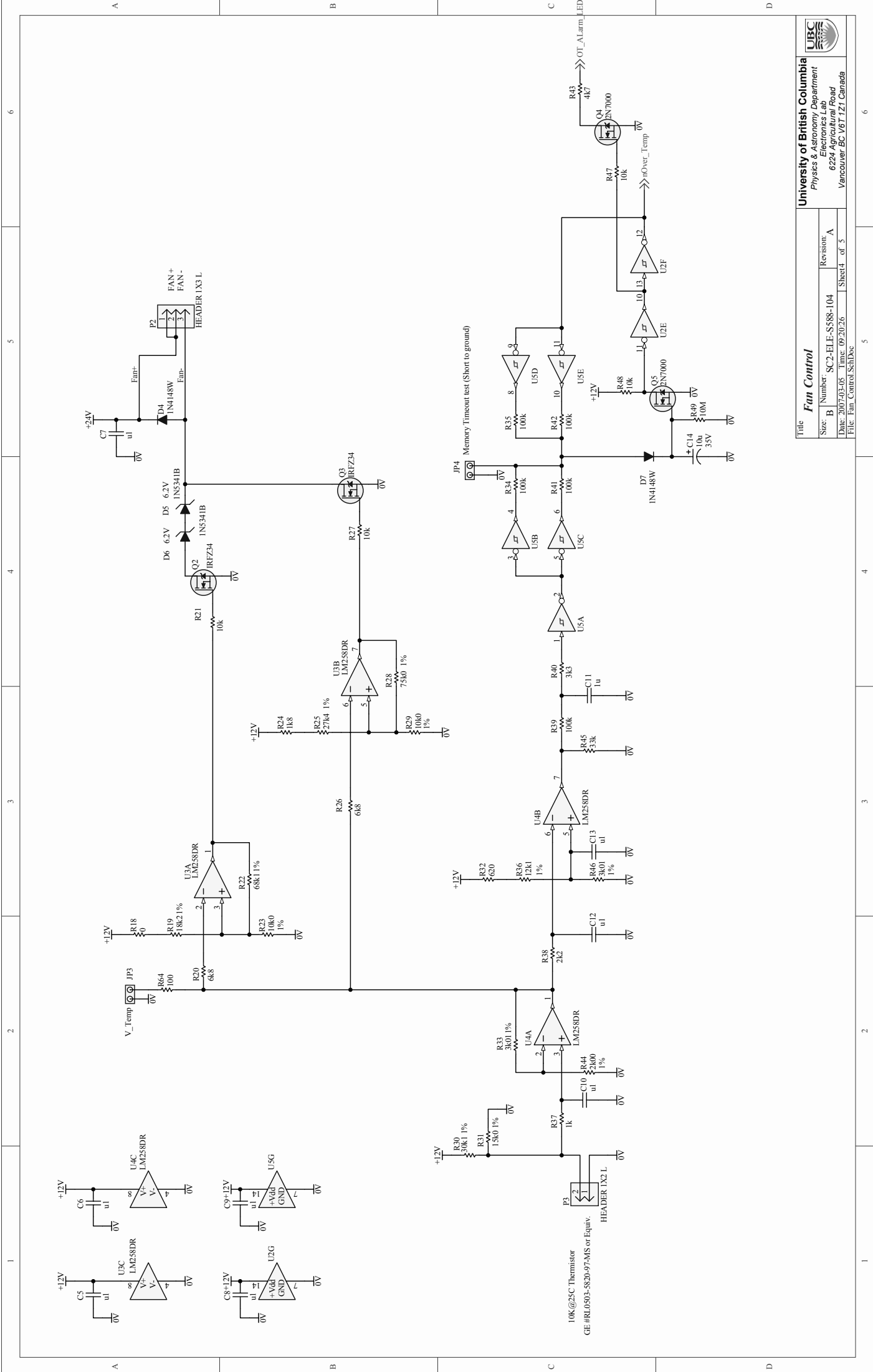

<b>University of British Columbia</b> Physics & Astronomy Department 6224 Agricultural Road Vancouver BC V6T 1Z1 Canada	
Title <b>Fan Control</b>	Revision A
Size B	Number SC2-ELE-S588-104
Date 2007-03-05	Time 09:20:26
File Fan Control.SchDoc	Sheet 4 of 5

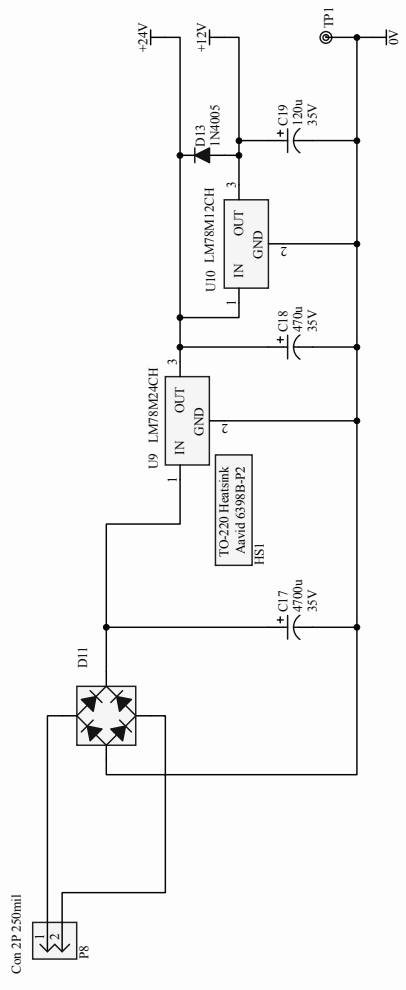

<b>University of British Columbia</b> Physics & Astronomy Department 6224 Agricultural Road Vancouver BC V6T 1Z1 Canada	
Title <b>Power</b>	Revision: A
Size: B Number: SC2-ELE-S588-104	Sheet 5 of 5
Date: 2007-03-05 Time: 09:20:26 File: Power_Sch.Dwg	