

1

2

3

4

5

6

A

A

B

B

C

C

D

D

SH1
C587-201_S1.SchDoc



SH2
C587-201_S2.SchDoc



SH3
C587-201_S3.SchDoc



SH4
C587-201_S4.SchDoc



SH5
C587-201_S5.SchDoc

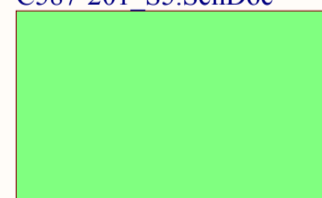

SH6
C587-201_S6.SchDoc



SH7
C587-201_S7.SchDoc

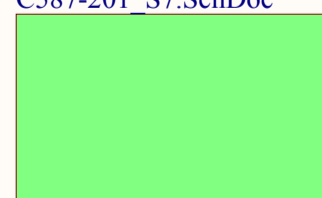

MCE Assembly #: 002506 ASY

Title		<i>MCEv2 5 MDM Instrument Backplane</i>		University of British Columbia Department of Physics & Astronomy MCEv2 Project 6224 Agricultural Road Vancouver BC V6T 1Z1 Canada				
Size:	B	Number:	ELE-C587-201				Revision:	B Issue 0
Date:	2012-07-09	Time:	10:40:14 AM				Sheet	0 of 5
File: C587-201_S0.SchDoc								

1

2

3

4

5

6

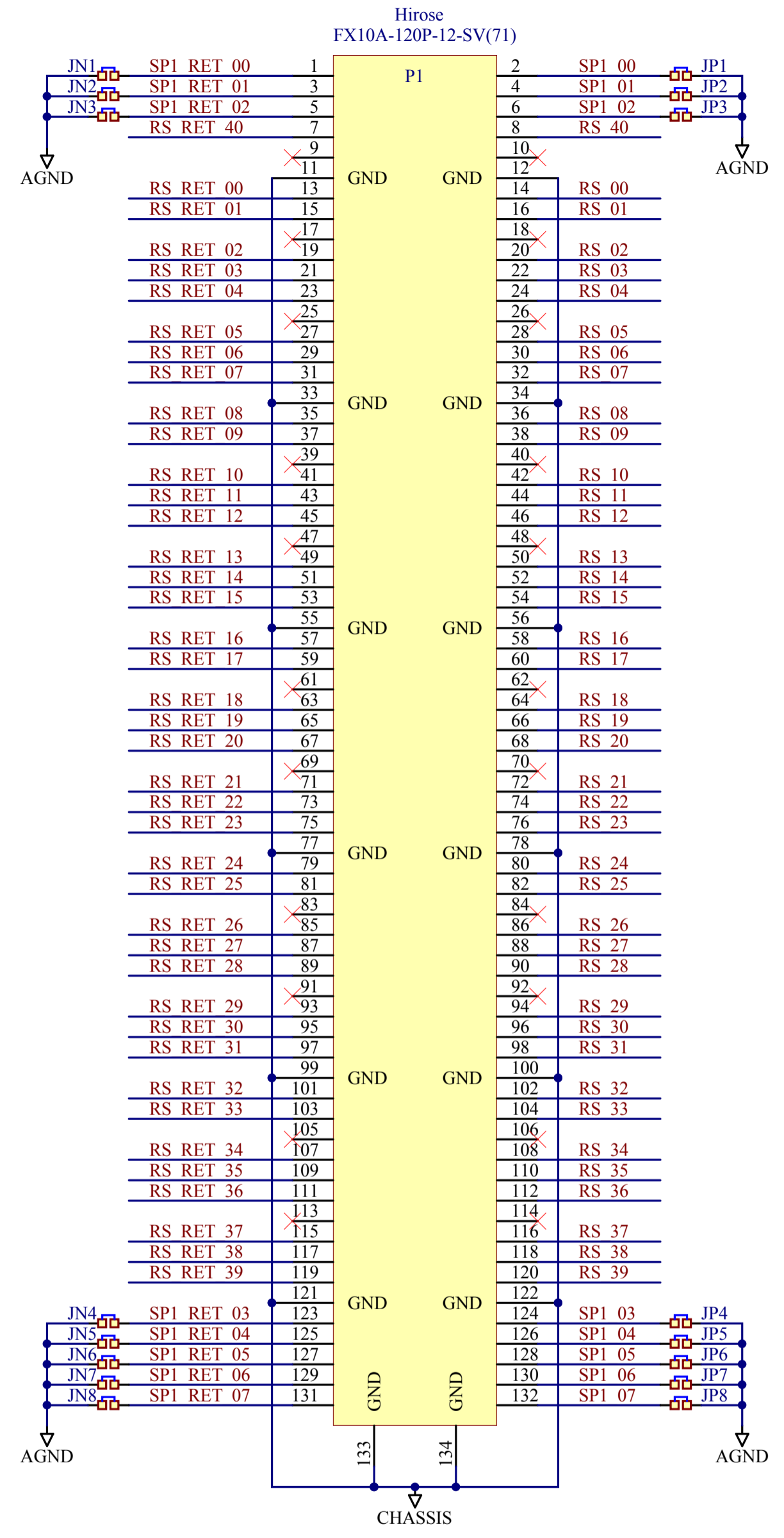
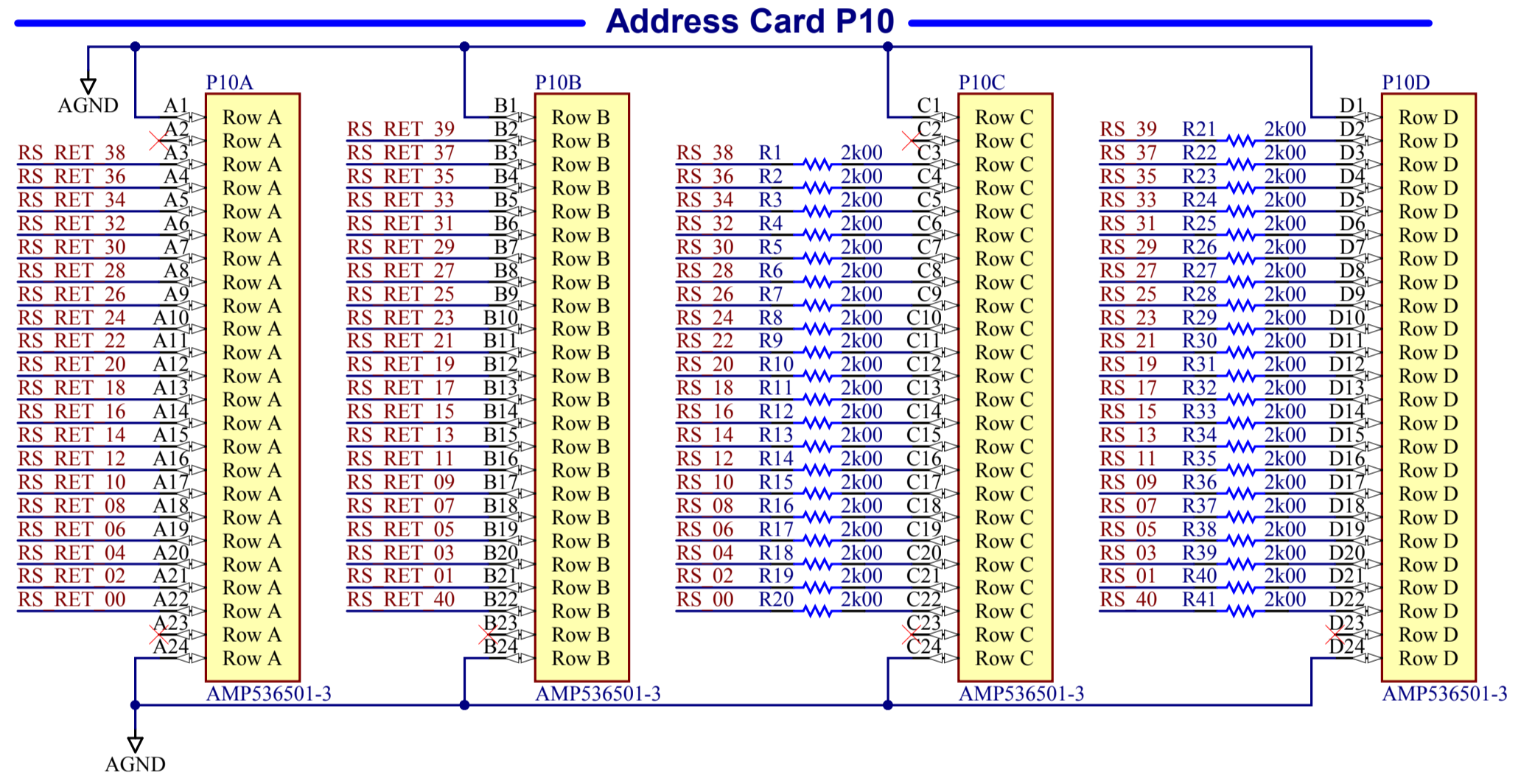

PCB Part Number for BOM: 002505 PCB
MCE Assembly #: 002506 ASY

Title: MCEv2 5 MDM Instrument Backplane			University of British Columbia Department of Physics & Astronomy MCEv2 Project 6224 Agricultural Road Vancouver BC V6T 1Z1 Canada	
Size: B	Number: ELE-C587-201	Revision: B Issue 0		
Date: 2012-07-09	Time: 10:40:15 AM	Sheet 1 of 7		
File: C587-201 S1.SchDoc				

Bias Card 1 - P11

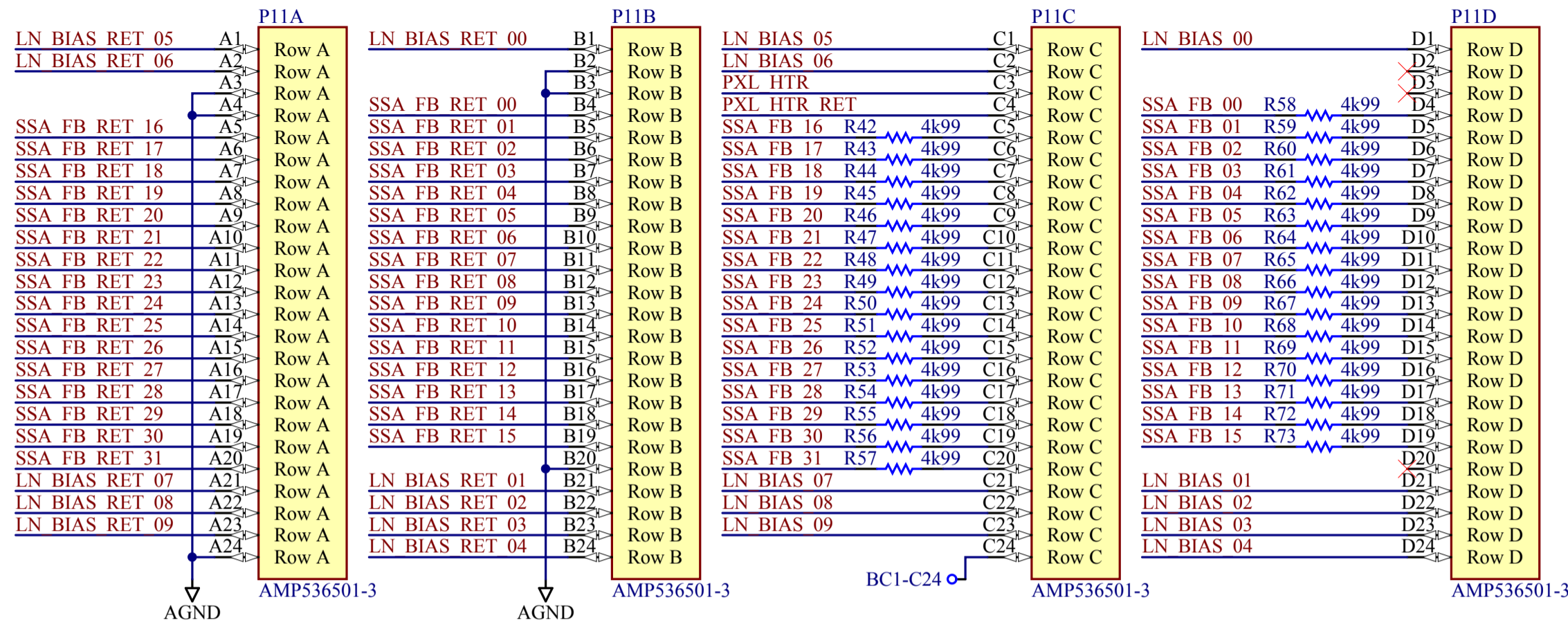

Bias Card 2 - P12

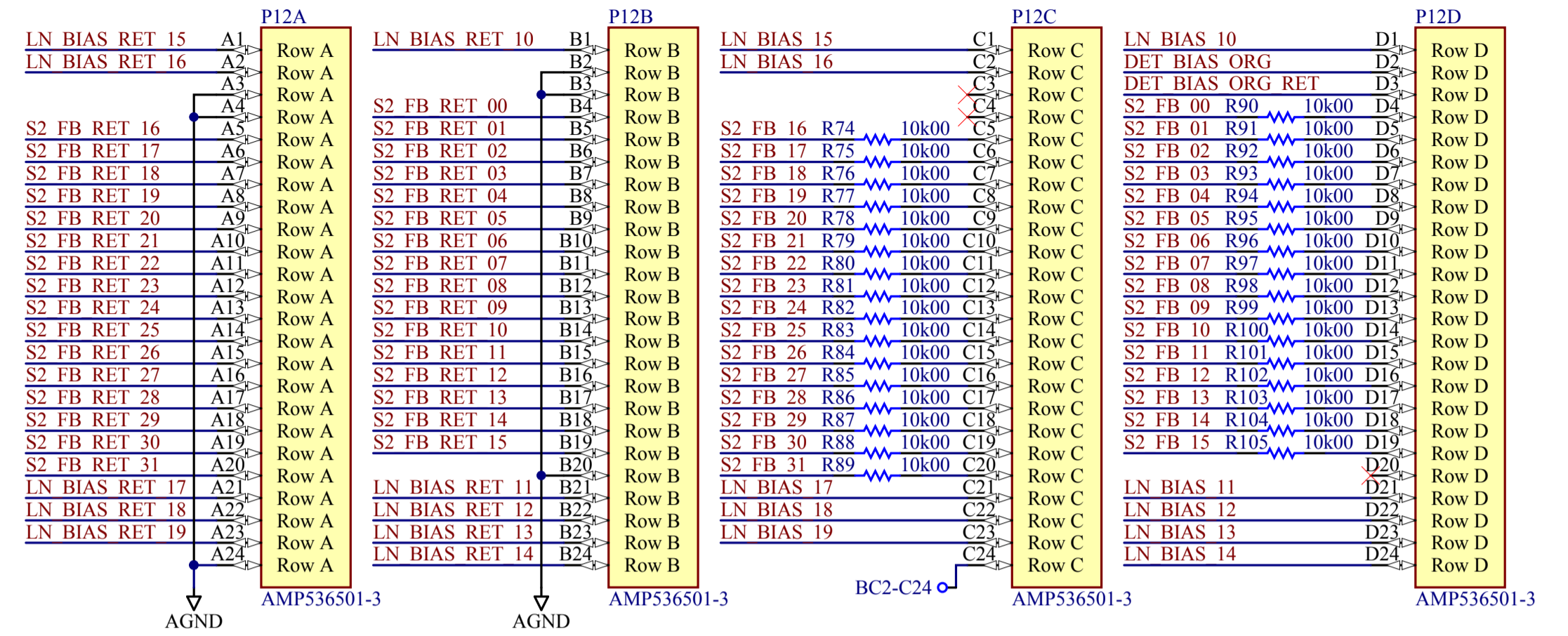

Note 1: BC2 is compatible with Address Cards
 Note 2: Compatibility Requires no Connection at C3, C4 for Bias Card 2 & 3
 Note 3: BC1-BC3 are not compatible with Bias Cards that have SSAM_HTR_A and B parts installed

Bias Card 3 - P13

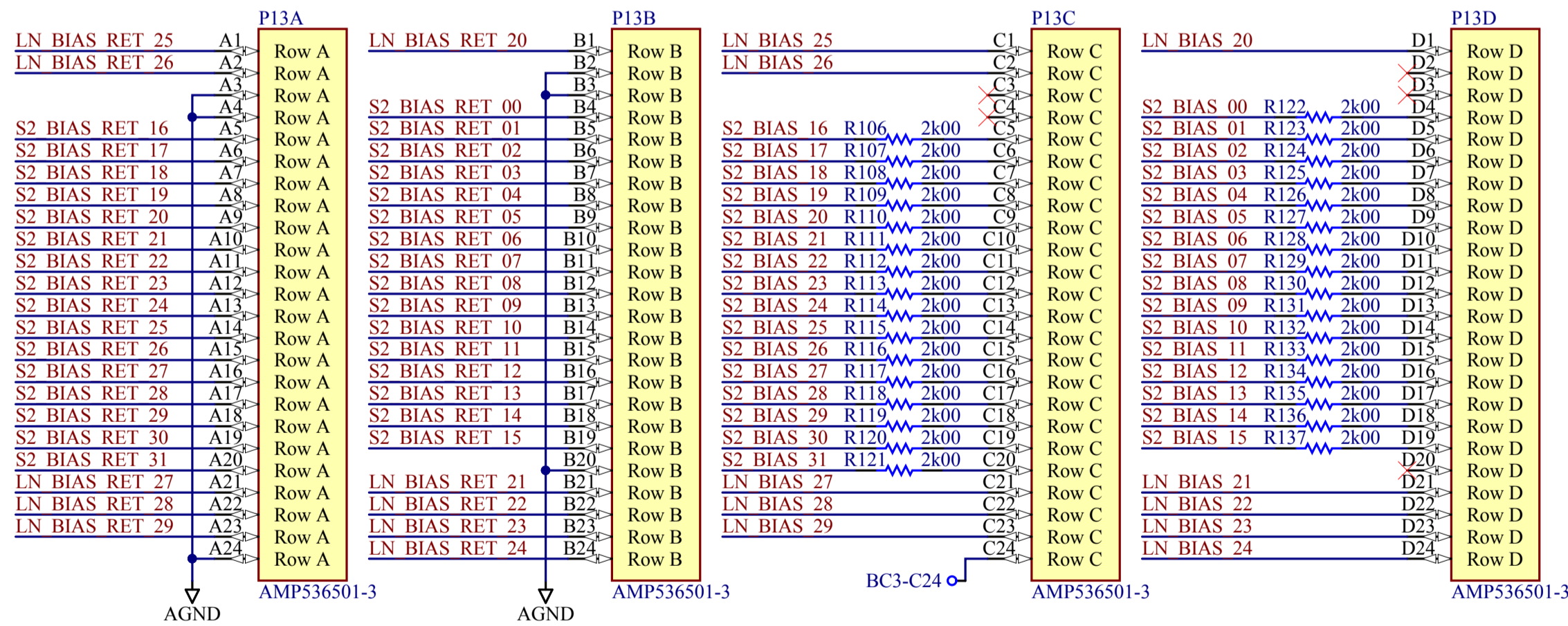

Readout Card 1 - P14

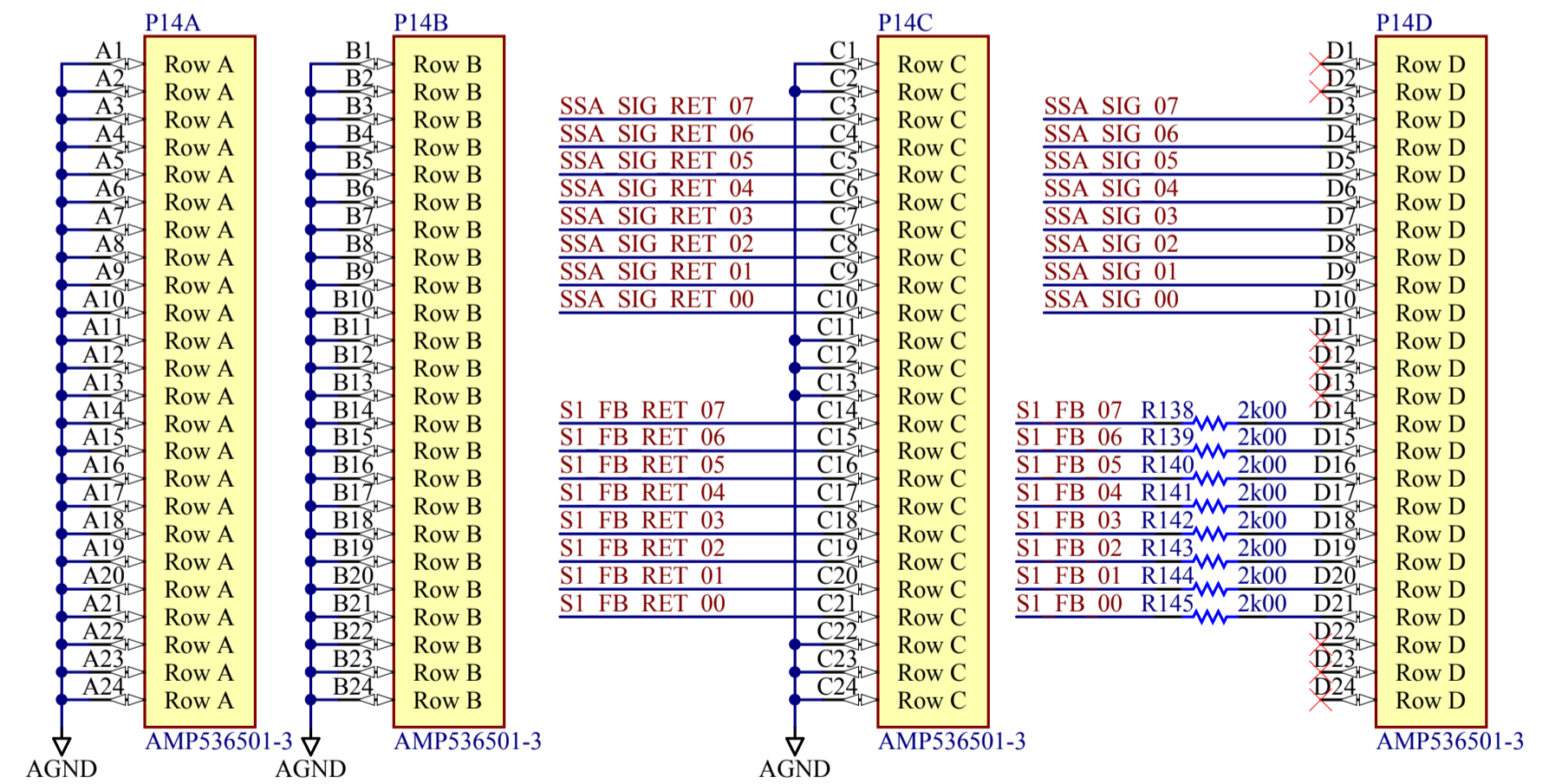

SSA_SIG_x Signals are Outputs from Array (Inputs on ReadoutCards)
 S1_FB_x Signals are Inputs to Array (Outputs on Readout Cards)

MCE Assembly #: 002506 ASY

Title: MCEv2 5 MDM Instrument Backplane		
Size: B	Number: ELE-C587-201	Revision: B Issue 0
Date: 2012-07-09	Time: 10:40:15 AM	Sheet 2 of 7
File: C587-201 S2.SchDoc		

University of British Columbia
 Department of Physics & Astronomy
 MCEv2 Project
 6224 Agricultural Road
 Vancouver BC V6T 1Z1 Canada



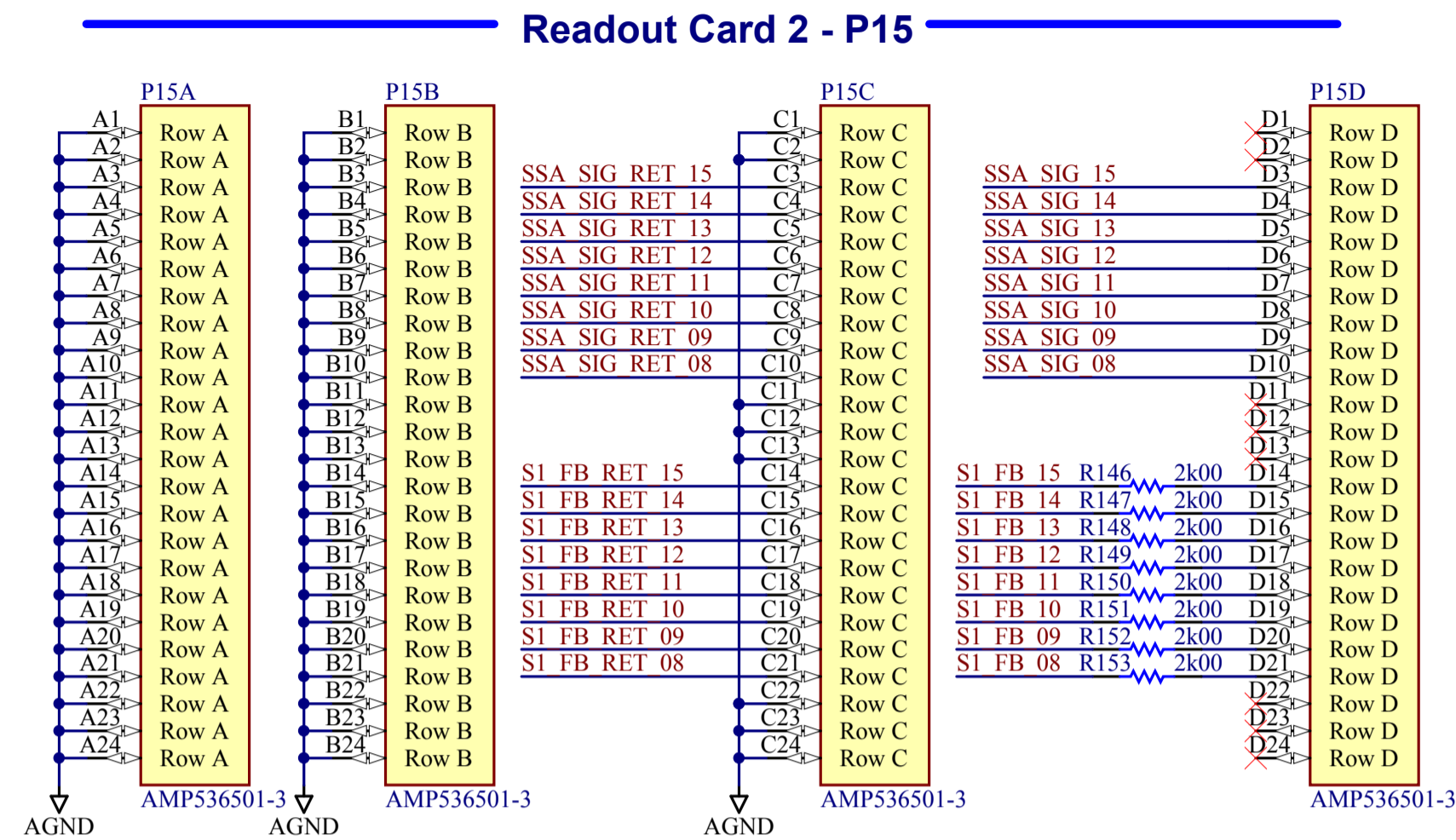

SSA_SIG_x Signals are Outputs from Array (Inputs on ReadoutCards)
 S1_FB_x Signals are Inputs to Array (Outputs on Readout Cards)

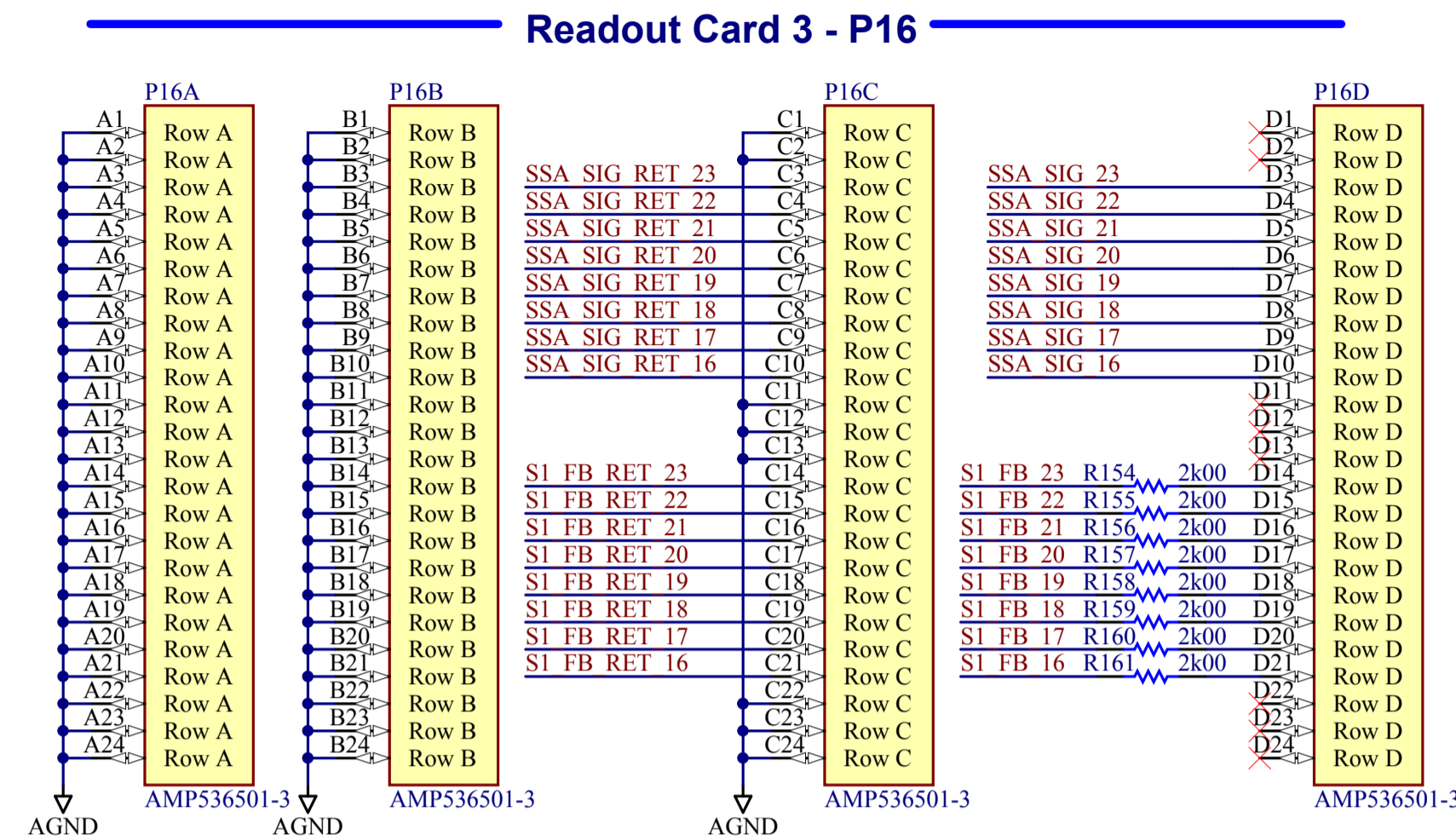

SSA_SIG_x Signals are Outputs from Array (Inputs on ReadoutCards)
 S1_FB_x Signals are Inputs to Array (Outputs on Readout Cards)

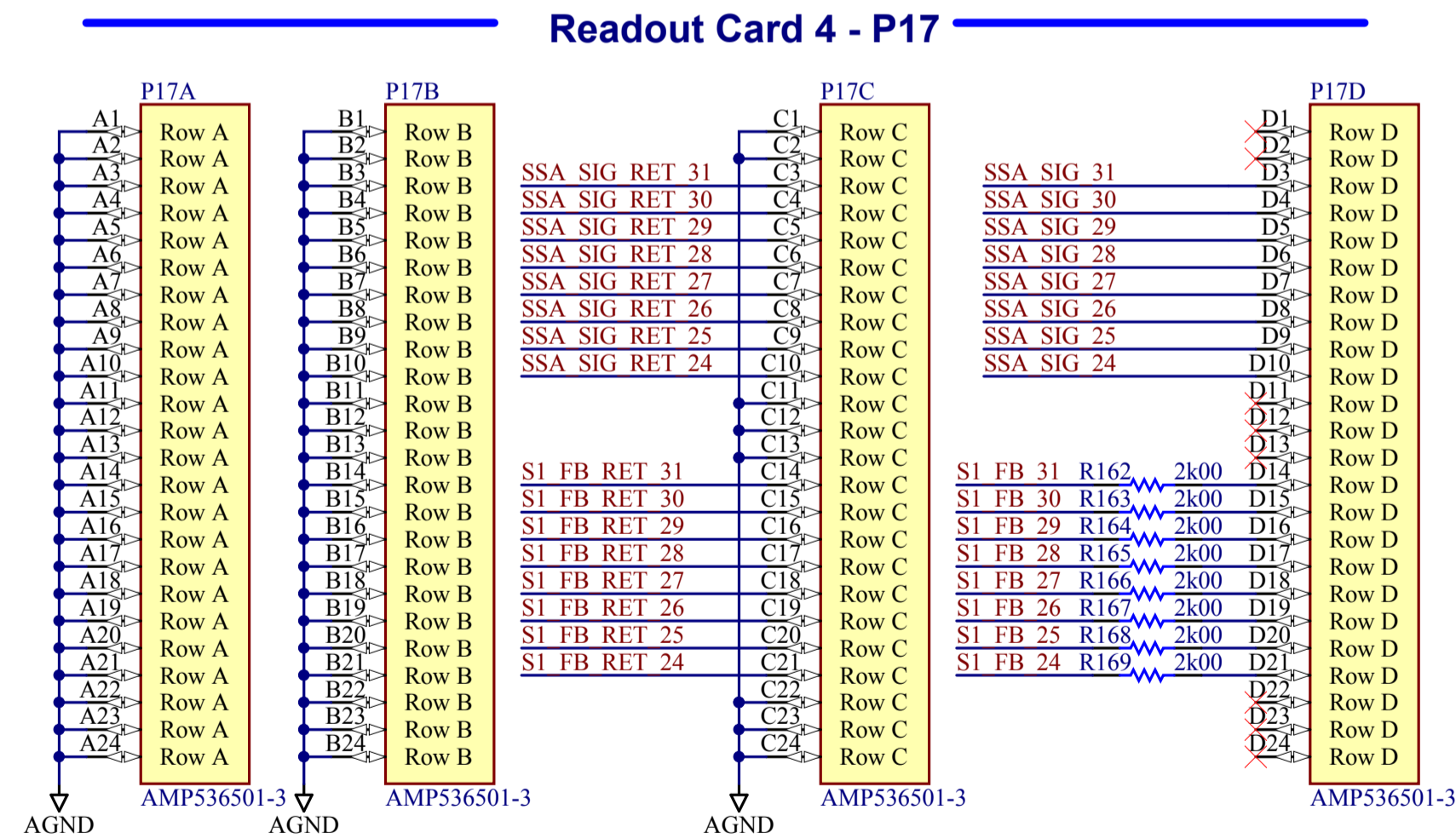

SSA_SIG_x Signals are Outputs from Array (Inputs on ReadoutCards)
 S1_FB_x Signals are Inputs to Array (Outputs on Readout Cards)

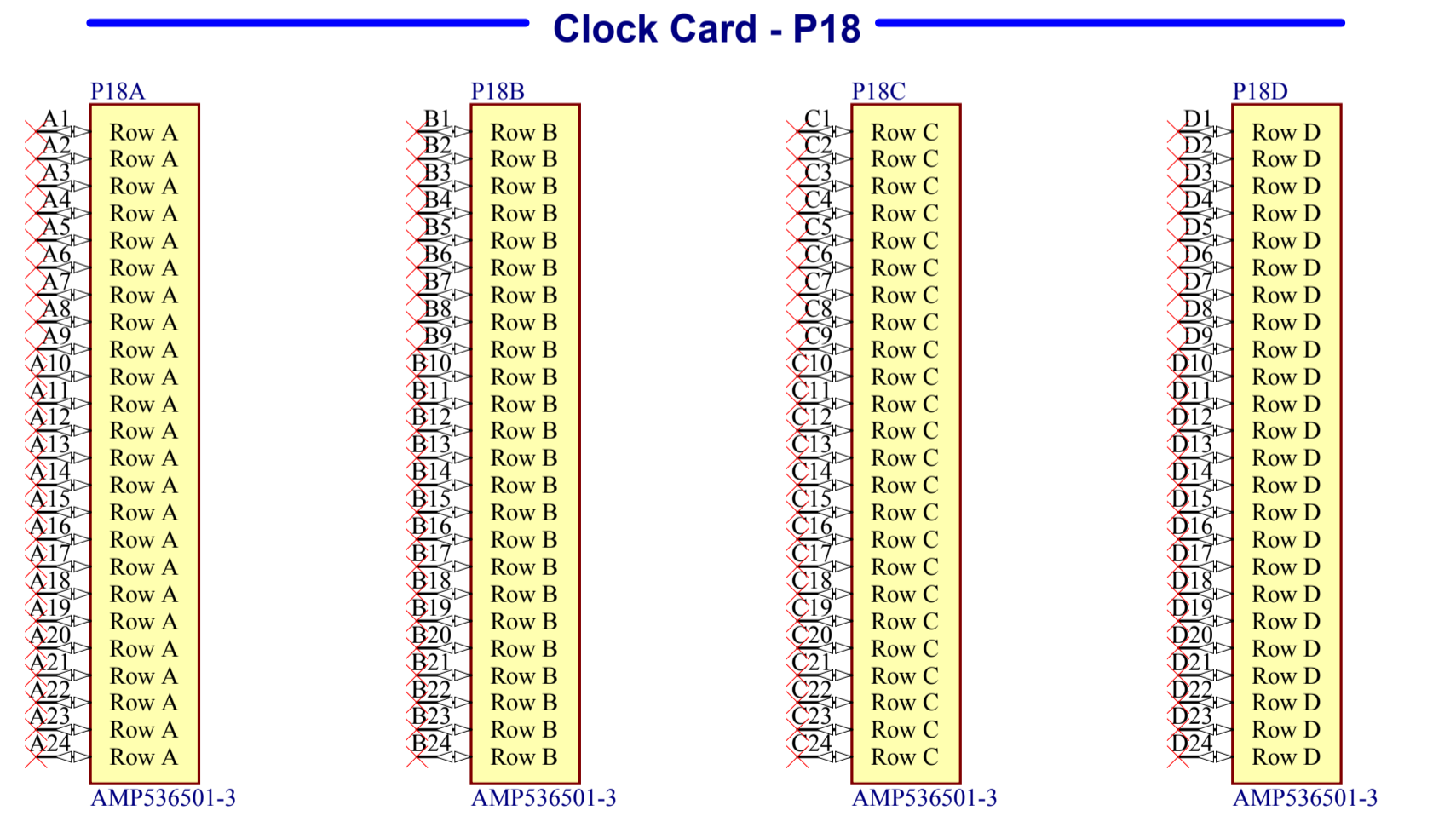

MCE Assembly #: 002506 ASY

Title: MCEv2 5 MDM Instrument Backplane			University of British Columbia Department of Physics & Astronomy MCEv2 Project 6224 Agricultural Road Vancouver BC V6T 1Z1 Canada	
Size: B	Number: ELE-C587-201	Revision: B Issue 0		
Date: 2012-07-09	Time: 10:40:16 AM	Sheet 3 of 7		
File: C587-201_S3.SchDoc				

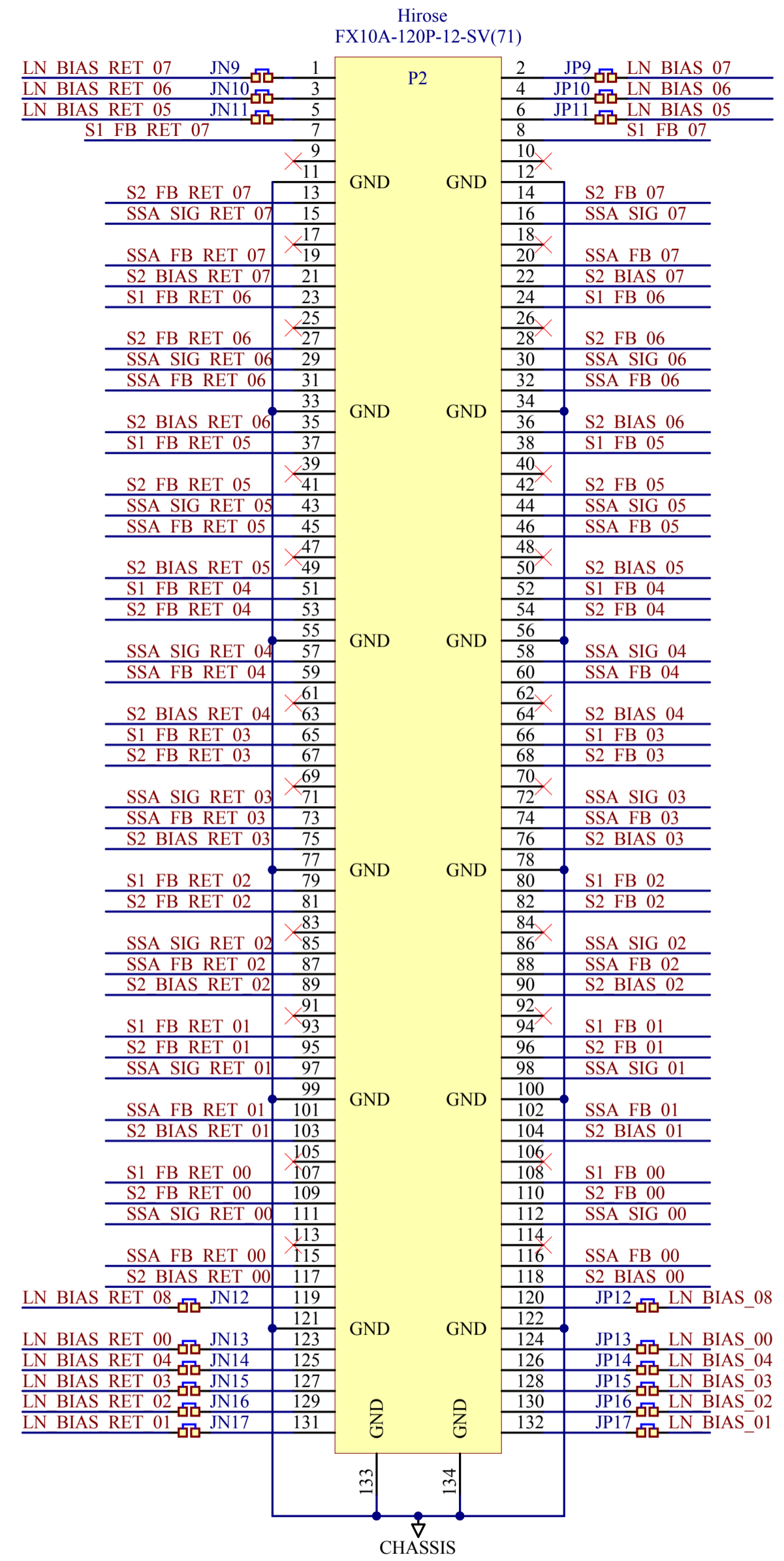
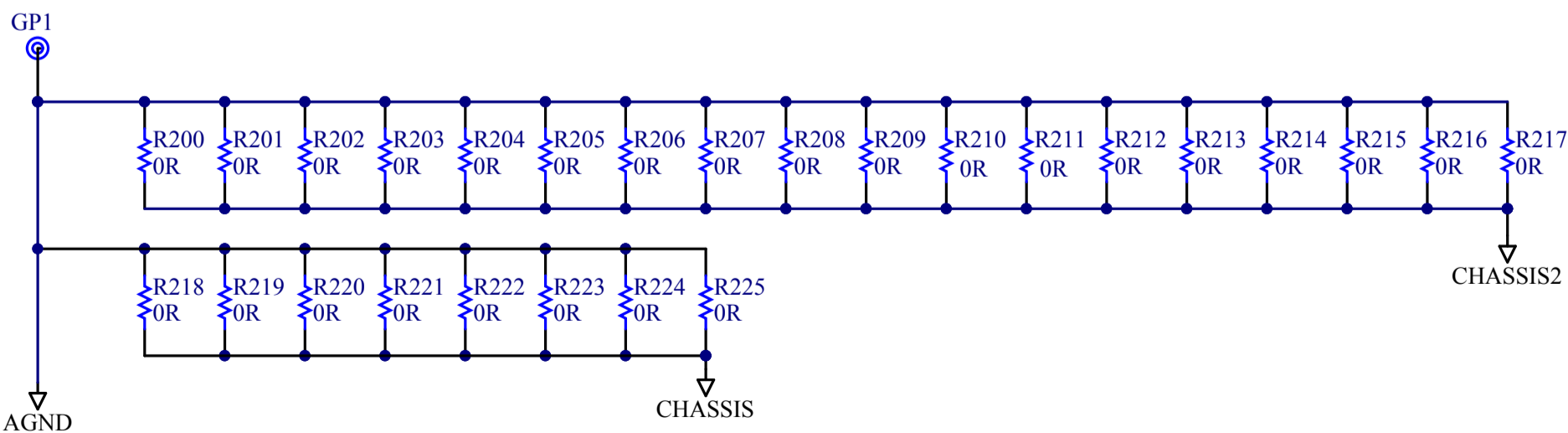

MCE Assembly #: 002506 ASY

Title		MCEv2 5 MDM Instrument Backplane		University of British Columbia	
Size: B	Number: ELE_C587-201	Revision: B Issue 0	Department of Physics & Astronomy		
Date: 2012-07-09	Time: 10:40:16 AM	Sheet 4 of 7	MCEv2 Project		
File: C587-201_S4.SchDoc				6224 Agricultural Road	
				Vancouver BC V6T 1Z1 Canada	



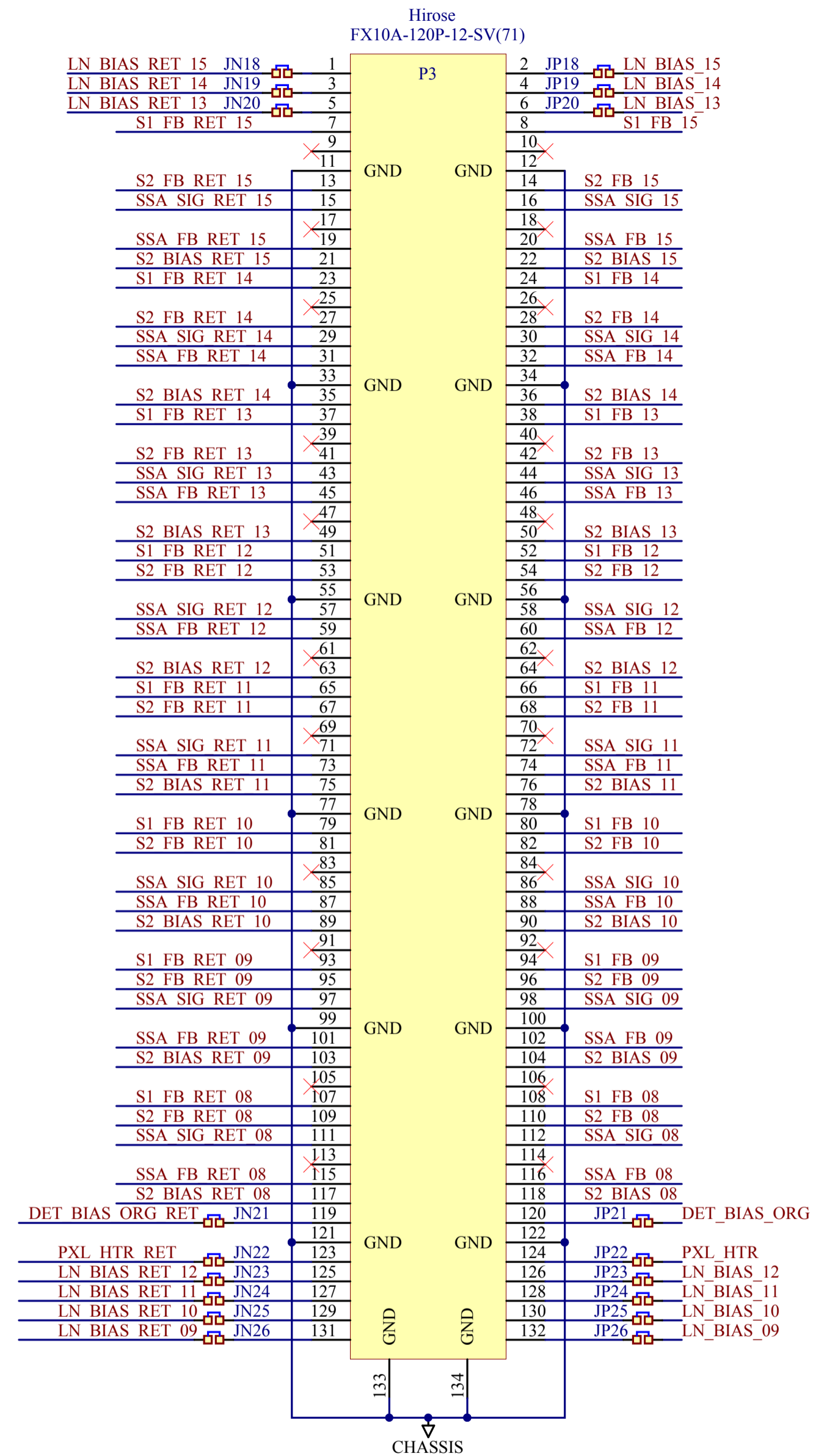



MCE Assembly #: 002506 ASY

Title		MCEv2 5 MDM Instrument Backplane		University of British Columbia	
Size: B		Number: ELE-C587-201		Department of Physics & Astronomy	
Date: 2012-07-09		Time: 10:40:16 AM		MCEv2 Project	
Revision: B Issue 0		Sheet 5 of 7		6224 Agricultural Road	
File: C587-201_S5.SchDoc				Vancouver BC V6T 1Z1 Canada	

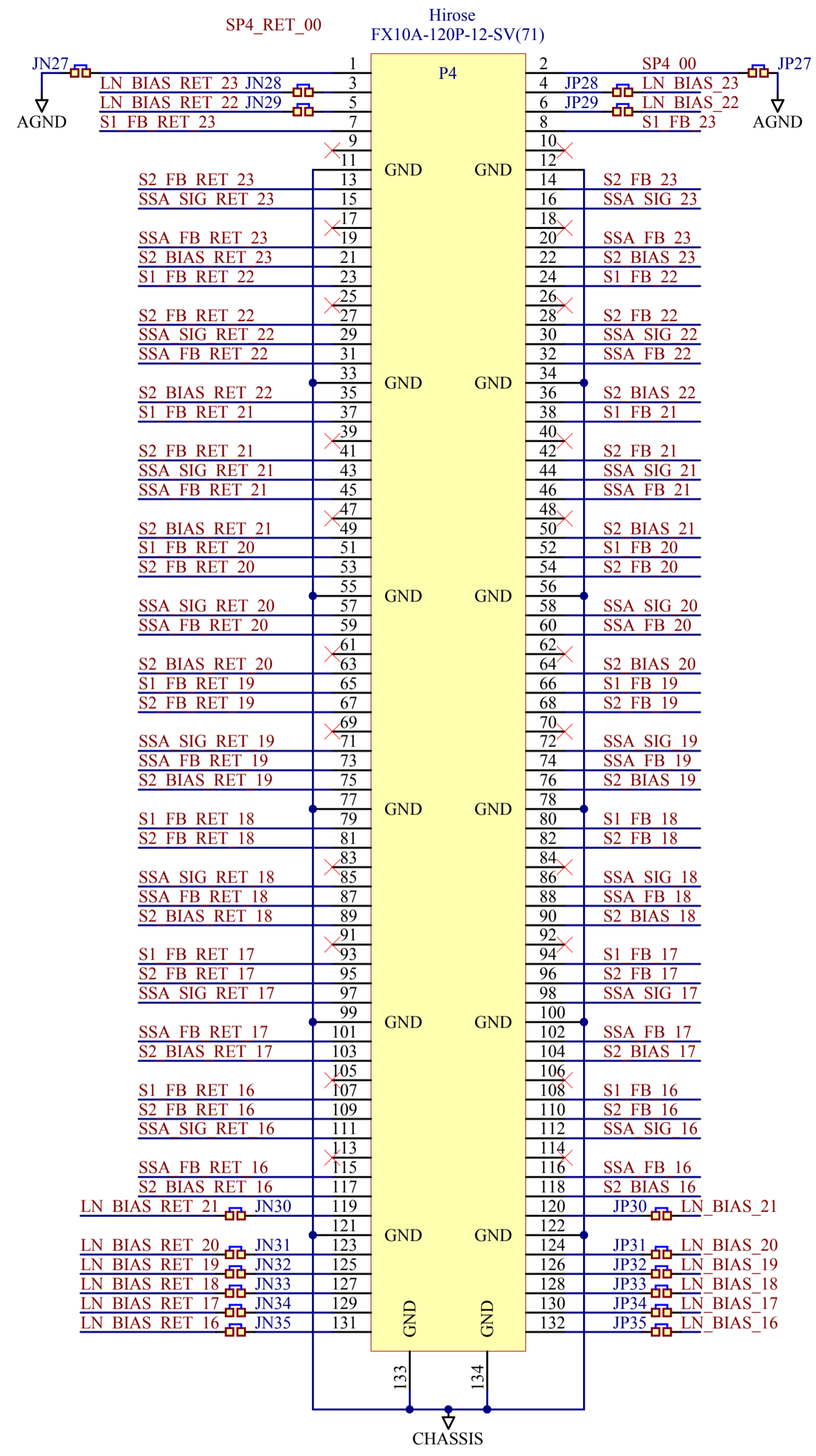



MCE Assembly #: 002506 ASY

Title		MCEv2 5 MDM Instrument Backplane		University of British Columbia Department of Physics & Astronomy MCEv2 Project 6224 Agricultural Road Vancouver BC V6T 1Z1 Canada				
Size:	B	Number:	ELE-C587-201				Revision:	B Issue 0
Date:	2012-07-09	Time:	10:40:17 AM				Sheet	6 of 7
File: C587-201_S6.SchDoc								

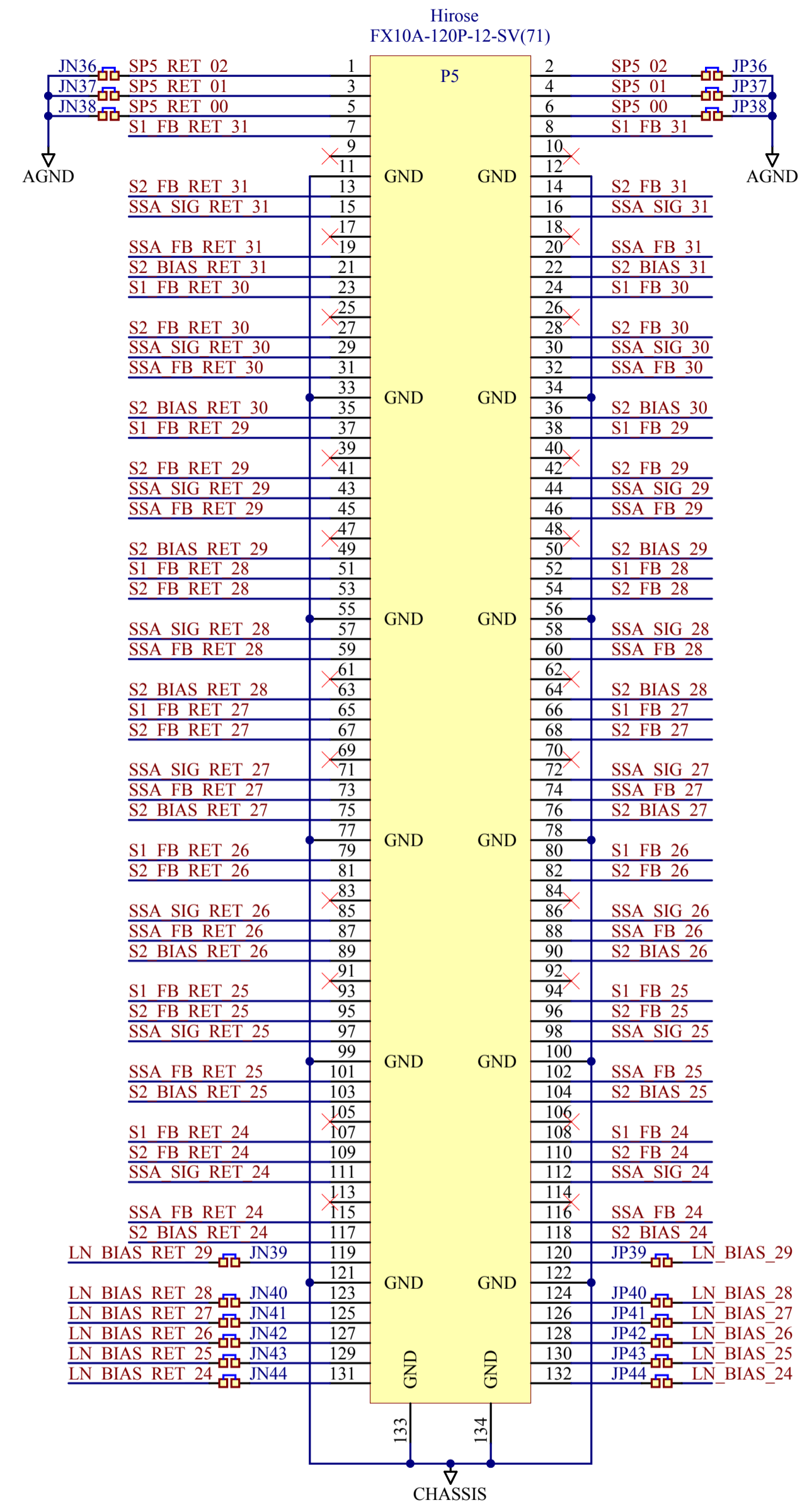

Use UBC Logo
 Add Fiducial Point
 Add Fiducial Point
 MCE Assembly #: 002506 ASY

Title		MCEv2 5 MDM Instrument Backplane		University of British Columbia	
Size: B		Number: ELE-C587-201		Department of Physics & Astronomy	
Date: 2012-07-09		Time: 10:40:17 AM		MCEv2 Project	
Revision: B Issue 0		Sheet 7 of 7		6224 Agricultural Road	
File: C587-201_S7.SchDoc				Vancouver BC V6T 1Z1 Canada	



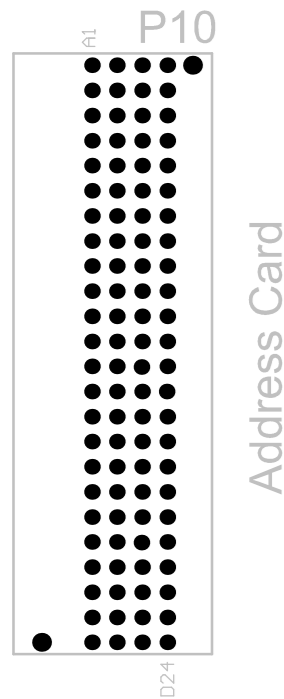

Address Card

002505 PCB
002506 ASY

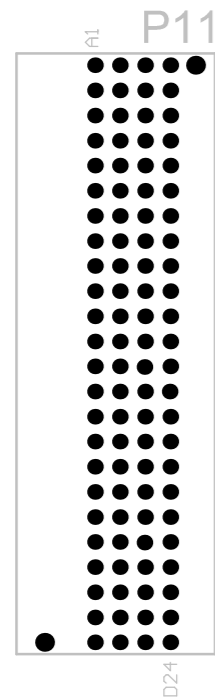

Bias Card 1

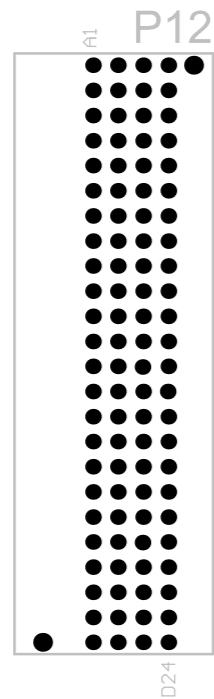

Bias Card 2

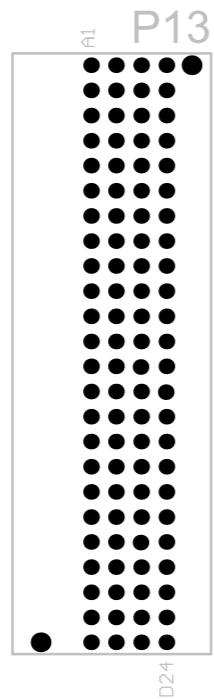

Bias Card 3

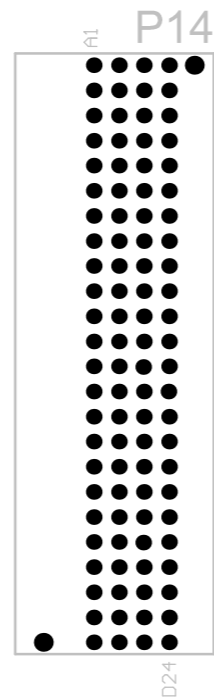

Readout Card 1

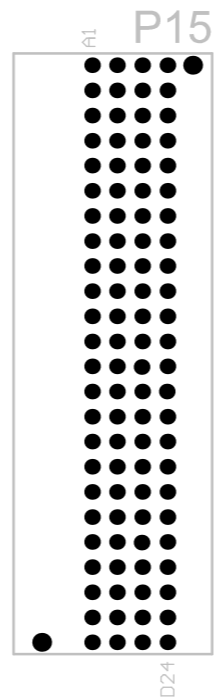

Readout Card 2

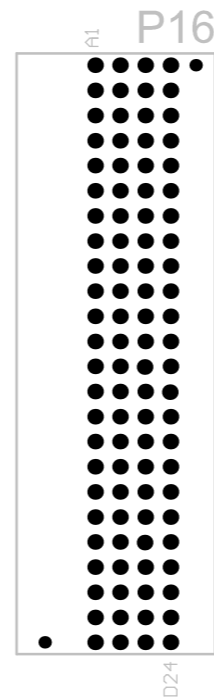

Readout Card 3

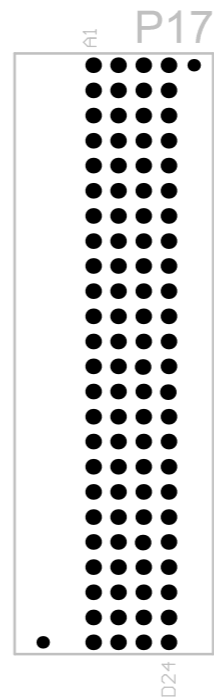

Readout Card 4

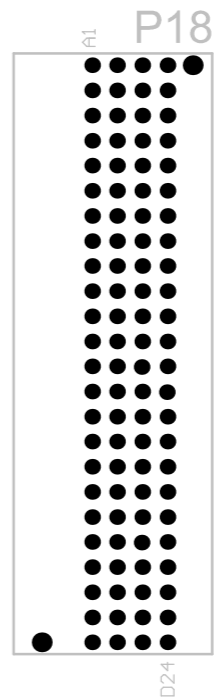

Clock Card

MCEv2 - 5 MDM INSTRUMENT BACKPLANE



University of British Columbia
Department of Physics & Astronomy - MCE Lab
ELE-C587-201 Rev B

Layer Name: Top Overlay
C587-201_Inst_BP.PcbDoc
Filename: Top Assembly Drawing

Layer Name
Top Layer
Sig1
Ret1
Sig2
Ret2
Sig3
Ret3
Sig4
Ret4
Bottom Layer

ELE-C587-201 Rev B
 Department of Physics & Astronomy - MCE Lab
 University of British Columbia
 MCEv2 - 2 MDM INSTRUMENT BACKPLANE

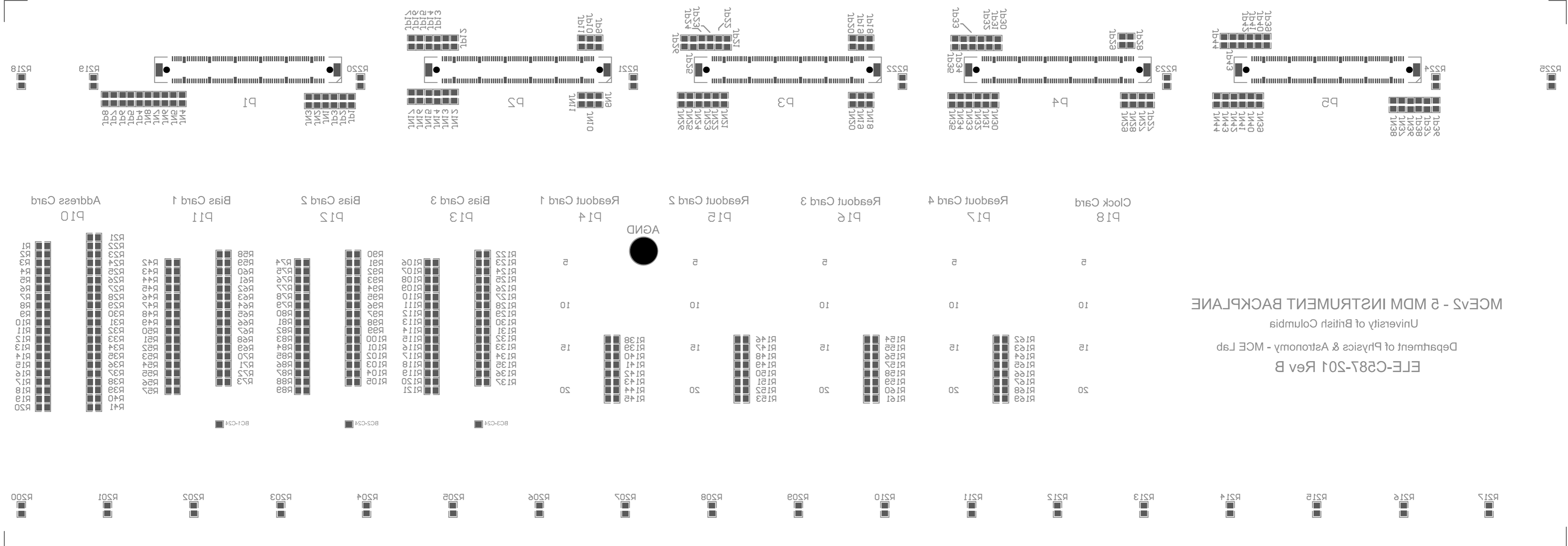

Layer Name: Bottom Overlay
 C587-201_Inst_BP.PcbDoc
 Filename: Bottom Assembly Drawing

Layer Stack Up Detail for C587-201_Inst_BP.PcbDoc

Layer Name
Top Layer
Sig1
Ret1
Sig2
Ret2
Sig3
Ret3
Sig4
Ret4
Bottom Layer